

National Examinations – May 2019

98-Mar-B6, Electrical and Electronics Engineering

3 hours duration

Name [print]:

Signature:

Notes:

- [1] If doubt exists as to the interpretation of any question, the candidate is urged to submit, with the answer paper, a clear statement of any assumptions made.
- [2] Candidates may use one of two calculators, the Casio or Sharp approved models. This is a closed book examination.
- [3] This examination consists of the front page and 8 numbered pages.
- [4] Any five (5) questions constitute a complete paper. Only the first five questions as they appear in the answer book will be marked.
- [5] Each question is of equal value.
- [6] Clarity and organization of the answers are important.
- [7] The candidate is required to sign this examination paper and submit it with the solution booklets.
- [8] $\pi = 3.14159$
 $1 \text{ hp} = 746 \text{ W}$
 $\mu_0 = 4\pi \times 10^{-7} \text{ H m}^{-1}$

QUESTION 1

Consider the transistor circuit shown in Figure 1. All transistors can be assumed identical with a dc current gain β

Calculate the current transfer ratio for the circuit, I_2/I_1 , as a function of β .

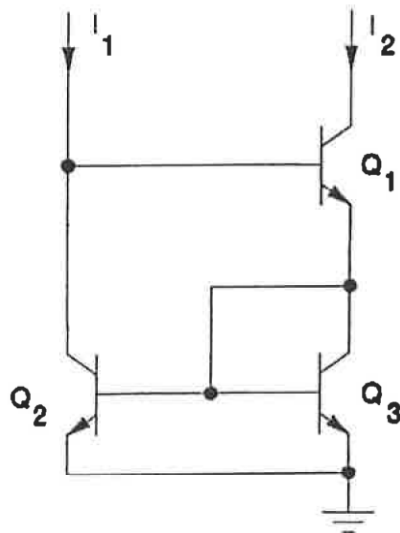

Figure 1 Transistor Circuit

QUESTION 2

This question consists of two parts which are not necessarily related.

Part I

A combinational logic circuit is shown in Figure 2.

- [a] Write a general Boolean algebra expression for the output F as a function of the inputs A,B.
- [b] Using DeMorgan's theorems and other Boolean identities, simplify the expression obtained in [a]. Is there a single gate which can replace the network shown?
- [c] Generate a truth table giving the logic levels at points C,D,E and F for inputs A,B.

Part II

Design a 2-input exclusive or (EOR) gate using only 2-input NOR gates.

- [d] Develop the truth table for the gate.
- [e] Write a general Boolean algebra expression for the output as a function of the inputs.
- [f] Using DeMorgan's theorems and other Boolean identities, modify the expression obtained in [e] to provide a solution which can be implemented with NOR gates.
- [g] Draw the circuit diagram for the final gate array.

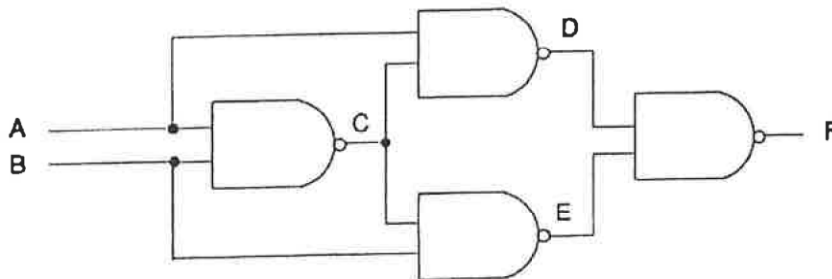

Figure 2 Combinational Logic Circuit

QUESTION 3

A linear dc machine consisting of a conducting bar resting on two conducting rails is shown in Figure 3. The magnetic flux density is 1 T, directed into the page, the resistor R is 0.05Ω , the rail separation is 1 metre and the battery voltage V_0 is 2V. Assume negligible friction between the bar and the rails.

- [a] Assume that the bar is stationary at time $t=0$ when the switch S_1 is closed. What is the magnitude and direction of the force on the bar at the start? What is the initial current flow? What is the speed of the bar assuming that no mechanical load is applied to the bar?
- [b] If the bar is loaded down with a force of 20N opposite to the direction of motion, determine the new steady state speed. Calculate the power delivered by the battery, the power delivered to the mechanical load and the power lost to heat in the resistance R . What is the efficiency of the machine under these circumstances?
- [c] The loading force in part [b] is removed and a mechanical pulling force of 10N, directed to the right, is applied to the bar. In steady state, determine the speed, the power taken from the mechanical source, the power delivered to the battery and the power lost to heat in the resistance R . What is the efficiency of the machine under these circumstances?

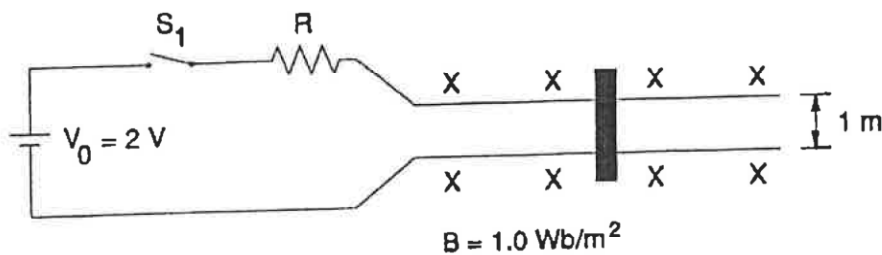

Figure 3 Top View of Linear dc Machine

QUESTION 4

Consider the magnetic circuit of a transformer shown in Figure 4. Infinite permeability can be assumed for the iron core. The following specifications apply.

$$\begin{array}{llll} d_1 = 3.77 \times 10^{-2} \text{ m} & A_1 = 0.02 \text{ m}^2 & N_1 \text{ (primary)} = 200 \text{ turns} \\ d_2 = 7.54 \times 10^{-2} \text{ m} & A_2 = 0.02 \text{ m}^2 & N_2 \text{ (secondary)} = 20 \text{ turns} \end{array}$$

When a dc voltage equal to 10 mV is applied to the primary winding, the measured primary current is 100 mA. When a dc voltage of 0.1 mV is applied to the secondary winding, the measured secondary current is 100 mA.

Assume that the leakage inductances, and eddy current and hysteresis losses are negligible; consider an operating frequency of 1000 Hz.

- [a] Draw the equivalent circuit for the transformer referred to the primary and calculate component values.
- [b] A transducer with an impedance of 0.078Ω is connected across the secondary of the transformer; an amplifier is connected to the primary. Calculate the output impedance of the amplifier to give maximum power transfer to the load.

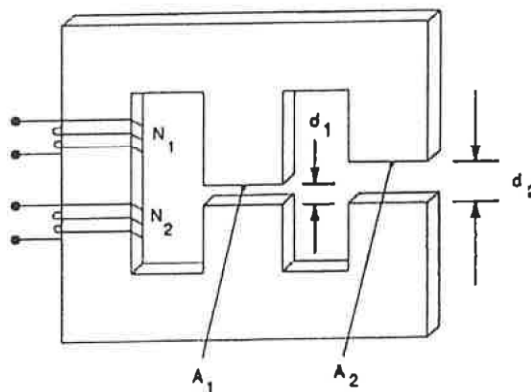

Figure 4 Transformer

QUESTION 5

Consider the circuit shown in Figure 5 which has been designed using ideal operational amplifiers (U_1 to U_3) with infinite bandwidth and infinite open loop gain. In the schematic, a, b and c are constants. You will note that U_3 is a basic difference amplifier which has a transfer function given by:

$$E_0 = c (e_y - e_x)$$

where e_y and e_x are the potentials at points y and x respectively.

In the derivation of the transfer function for such circuits, one can assume the following:

- (i) Zero differential voltage between the input terminals of the operational amplifier
- (ii) Zero current flows into either input terminal of the operational amplifier

Applying the principle of superposition, derive an expression for the transfer function of the total circuit (E_0 as a function of E_1, E_2).

Hint: Let $E_2 = 0$, and solve for the potentials at points x and y for input E_1 .
 Let $E_1 = 0$, and again solve for the potentials at points x and y for input E_2 .
 Calculate the resultant output E_0 for both E_1 and E_2 inputs.

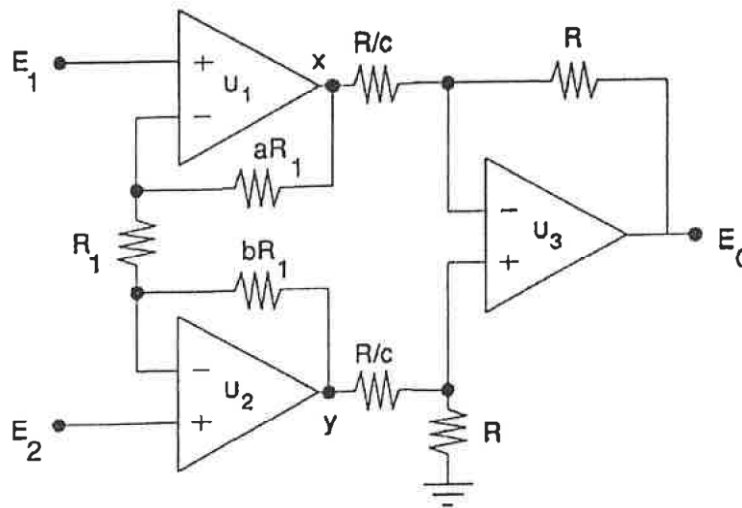

Figure 5 Circuit Schematic

98-Mar-B6/May 2019

QUESTION 6

Part I

A dc test is performed on a 208-V, six pole, delta connected, 60 Hz induction motor as shown in in Figure 6.

[a] If $V_{DC} = 3.32$ V and $I_{DC} = 3.1$ A, calculate the per phase stator resistance r_1 .

Three phase excitation is applied to the motor which runs with a slip of 3.5%. Find;

[b] The speed of the magnetic field in revolutions per minute.

[c] The speed of the rotor in revolutions per minute.

[d] The electrical frequency of the rotor current.

The load on the motor is now doubled. Calculate:

[e] The speed of the rotor in revolutions per minute.

Part II

You are provided with a graph of the speed-torque characteristic of a three phase wound rotor induction motor. The torque required to drive a pump is $T = K_p n^2$ (K_p is a constant; n is the speed in revolutions per second). The induction motor is to be used to drive the pump. Show how you would determine the operating point speed of the system.

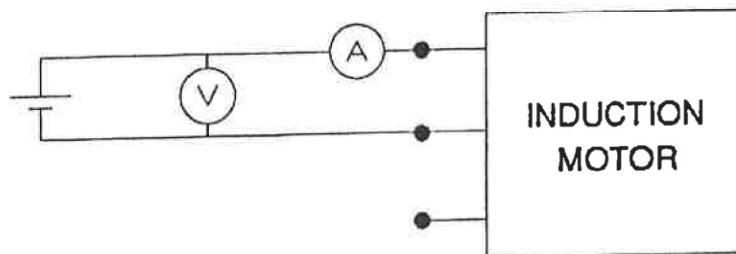

Figure 6 dc Test on Induction Motor

QUESTION 7

Consider the RC circuit shown in Figure 7[a]. The switch S_1 is closed at time $t=0$ connecting the dc supply V_1 to the network.

[a] Derive an expression for the transfer function, V_o/V_1 , in the time domain.

[b] Sketch the transfer function for a time interval of 5 time constants.

The RC circuit is reconfigured as shown in Figure 7[b]. An ac voltage source of variable frequency v_i is connected to the input.

[c] Derive an expression for the transfer function, v_o/v_i , in the frequency domain.

[d] Sketch the magnitude of the transfer function for a frequency range of 4 decades centered at the corner frequency of the circuit.

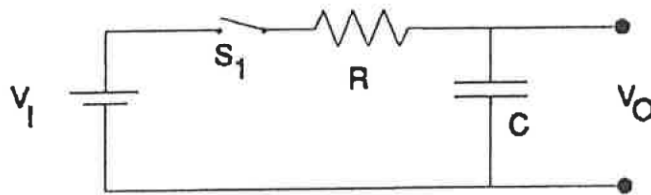

[a]

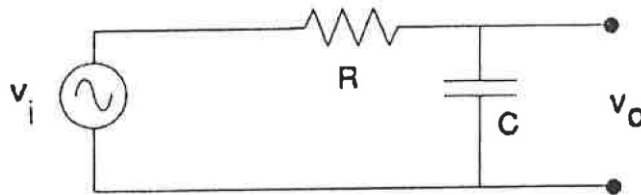

[b]

Figure 7 RC Circuit: [a] dc test; [b] ac test

QUESTION 8

An industrial load is represented in Figure 8 by $R = 6\Omega$ and $X_L = 8\Omega$. The load voltage is $250 \angle 0^\circ V$.

- [a] Calculate the load current, power, reactive power and power factor.
- [b] Calculate the generator voltage V_G required at the input end of the transmission line (represented by the series impedance $Z_T = (1 + j3)\Omega$) and the power lost in transmission P_T .
- [c] If capacitor $X_C = 12.5\Omega$ is connected in parallel by closing switch S, calculate I_C , the new load current I , and the new power factor. Show V , I_L , I_C and I on a phasor diagram.
- [d] Calculate the new generator voltage and the new transmission power loss.
- [e] What two advantages do you see for improving the power factor by adding a parallel capacitor?

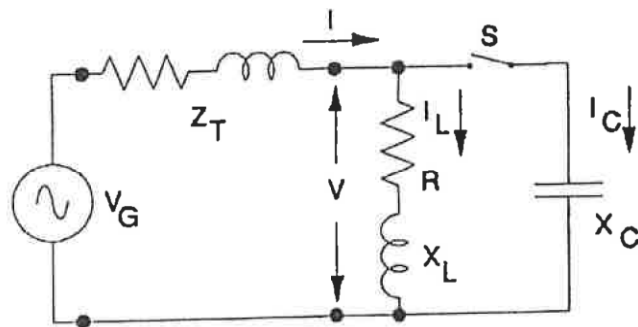

Figure 8 Industrial Load